



Automatic edge banders

**ME 15 - ME 20**

**TECNOMAX**

# TECNOMAX

a company of scm group

# TECNO



Factory



Foundry



Assembly line



Component manufacturing



Testing



Training



# OMMAX



Sheet processing



Mechanical processing



Painting



Groups assembly

## A GREAT GROUP, GREAT PRODUCTS, GREAT QUALITY

The **SCM Group** is a world leader for woodworking machinery. In its fifty-year history the Group has installed two million machines in 120 countries world-wide. Today, the **SCM Group** has 3.000 employees, 18 production facilities and 23 overseas branches. It exports over 70% of its production. The companies comprising the Group include some of the most prestigious names and brands in the woodworking machinery industry. **SCM**, founder of the SCM Group, produces machinery for small-, medium- and large-sized companies and has become the world leader for the production of CNC routing machines. **MINIMAX** and **TECNOMAX** are group companies manufacturing machinery for small carpentry workshops and the woodworker. **ROUTECH** specialises in CNC machining centres and is a leading innovator for routing technology. **CMS** is renowned for its high-productivity industrial machining centres. **MORBIDELLI** is a leading producer of industrial drilling machines and lines for the furniture industry. **GABBIANI** has been renowned since the sixties for its panel saw lines. **DMC**, originally the mechanical engineering division of furniture maker Castelli, was acquired by the SCM Group in the eighties and today is a world leader for industrial sanding machinery for the furniture industry. **IDM** and **STEFANI** are two major names for edge banding machinery and operate today as a single manufacturing company whose edge banders have become a bench mark for the European furniture industry. **MAHROS** produces automated handling and conveying systems for integrated production lines and manufacturing cells. **SCM GROUP ENGINEERING** designs and develops integrated systems. **Companies of the CMS Group** have recently joined the SCM Group adding expertise in **woodworking machinery and glass and marble machines tools** to the Group's already broad range of talents. SCM Group has always implemented a fully integrated manufacturing policy to guarantee that our customers get total quality. We prefer to do everything in-house. The Group has its own division specialising in the **design and manufacture of electrical, electro-mechanical and electronic equipment**. **Our two foundries, leaders on the Italian market, produce the small, medium and large size castings needed for our products. We have a company specialising in structural steel work.** The SCM Group has 20 years experience in professional training for the woodworking industry. Today our training strategy includes close collaboration with the Faculty of Engineering at the University of Bologna, the Fontys at Eindhoven in The Netherlands, the Wood Institute at the British Columbia University, Vancouver (Canada) and the Georgia Institute of Technology in Atlanta (USA). All SCM Group production facilities have **ISO 9001 quality assurance certification**.

# TECNO



# OMAX



## 100% MADE IN ITALY

**Tecnomax** is an **SCM Group company** which makes machines for professional use, from single-function machines to combined universal machines, continuing the great tradition of **SCM** which in 1952 made the first combination machine capable of a number of operations, now famous world-wide. **Tecnomax** uses state-of-the-art industrial structures able to guarantee complete quality control together with an effective, prompt after-sales service around the globe. A special group of designers develops the product and finds innovative solutions for always offering the customer the best quality to price ratio.

# TECNOMAX

## Automatic edge banders for the craft woodworker...

### > ME 15

Automatic edge bander  
for pre-glued edges



SINCERT



REG. N. 091/C  
UNI EN ISO 9001:2000

ME 15  
version in CE configuration

... compact, versatile and precise.  
Reliable and cost-effective, too.

> **ME 20**

Automatic edge bander  
with glue pot



**ME 20**  
version in CE configuration  
(with the **kit for wood rolled edges up to 2 mm thickness** assembled)

## “Simple technological solutions within everybody’s reach!”

### Panel thickness adjustment by means of handwheel with numerical readout (mm/inches)

Together with the panel thickness adjustment, at the same time also the feeder and trimming unit are automatically set at the selected height.



### Control panel ME 20

The control panel is ergonomically positioned on the front of the machine, in order to make the operation easier in any working condition.

### Top-mounted power panel feeder (0,18 kW)

A large, 995 x 72 mm, feeder belt ensures constant, powerful panel feed through the machine.

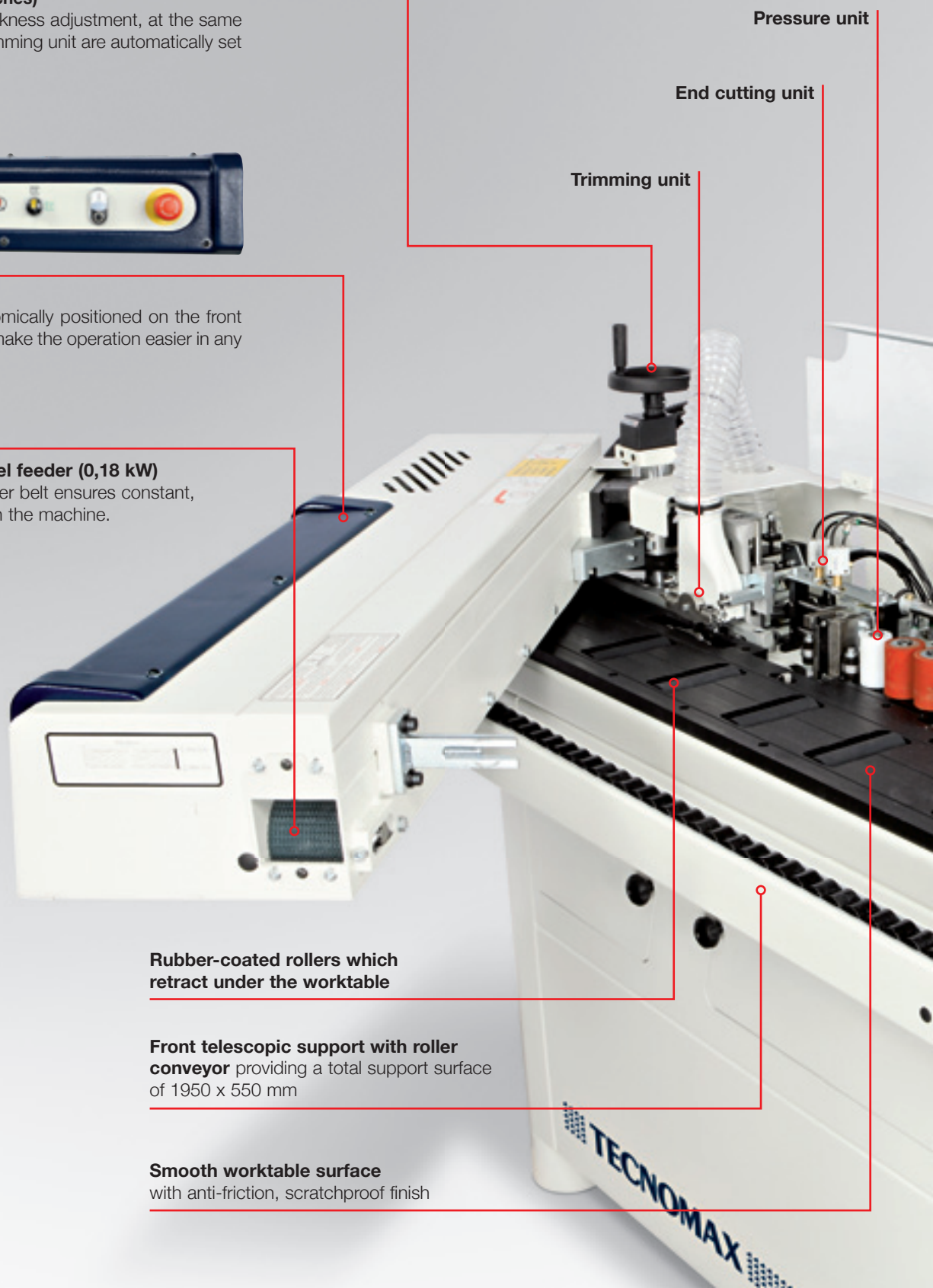



Blower unit (ME 15)  
Gluing unit (ME 20)

Loading unit

**Transparent guard cover**  
provides a complete overview of  
the edge banding cycle

**Easy-to-adjust infeed guide with  
numeric indicator**  
for setting edge band band width

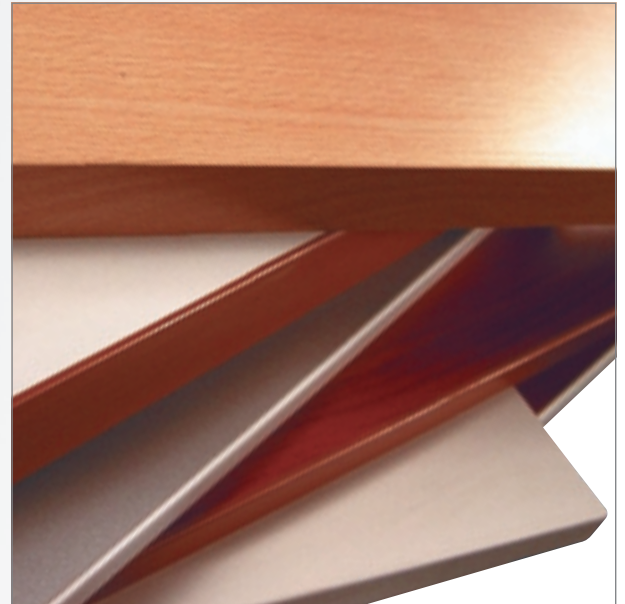

**Maximum result from a minimum effort!**  
The edges are perfectly glued to the panels  
and finished, all this through few simple  
operations, for a surprising result!



ME 15  
version in CE configuration

Standard edge roll plate 730 mm diameter

## Working units

### Loading unit

The unit is equipped with an automatic loader for edge band rolls with pneumatic guillotine and cutting reels. The edge feed is powered and automatic (N.B. only ME 20).

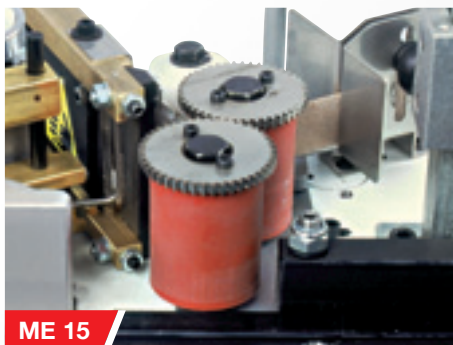

### Blower unit ME 15

The Leister blower has a maximum power of 3.400 watt and electronic temperature control from control panel. The blower is mounted inside the base for top efficiency and safety.

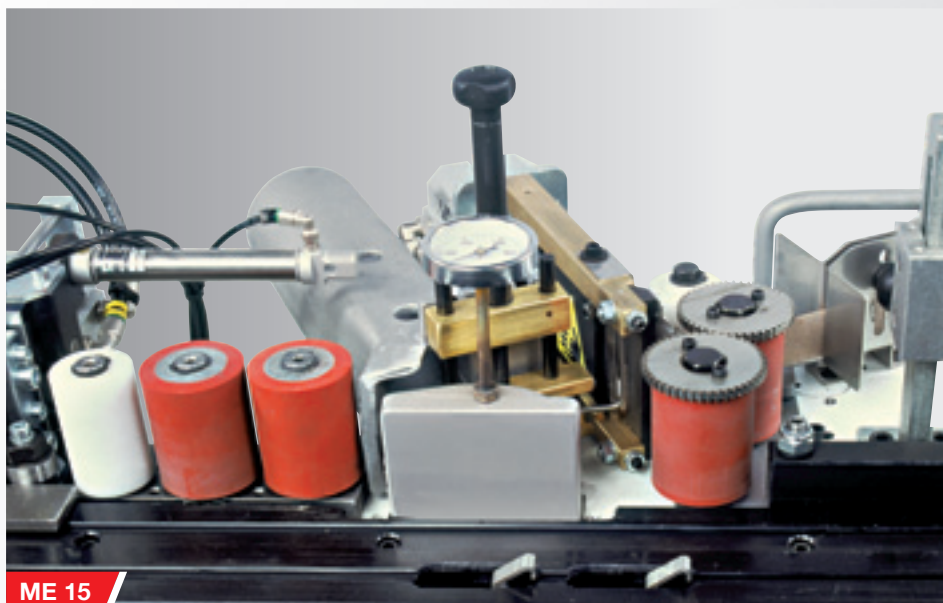

### Gluing unit ME 20

When the machine is not in use an electronic temperature controller keeps the machine at a constant 150°C. This prevents glue burning and ensures a rapid return to work when edge banding recommences.

The non-stick, aluminium glue tank with 5 resistances provides uniform glue melting and heating. The knurled glue roller has micrometric adjustment, to enable accurate control of the amount of glue spread on the panel, and is equipped with self-adjustment of glue spreading roller projection according to the panel and the edge thickness to be glued.

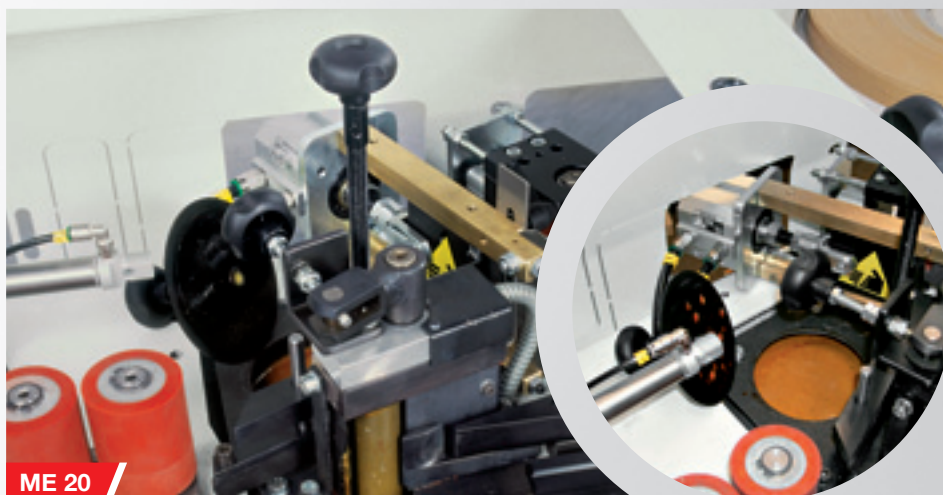

## Pressure unit

The unit has three rollers pressing the edge band onto the panel: one fixed nylon roller (white) and two rubber-coated rollers, the second of which pivots.



## Pneumatic end cutting unit

This has solid steel components to guarantee a clean, precision cut on the leading and trailing edges of the panel. Referencing is done directly from the panel and there is therefore no need for adjustment. The steel cutter block opposite the blade increases cutting efficiency and sharpens the cutting edge on each cycle.



## Trimming unit

Trimming unit adjustment is easy thanks to the precision numeric indicators. These give precise position readings to tenths of a millimeter. They ensure an easy, rapid return to previous settings.

Surplus edge banding is trimmed from the upper and lower surfaces by large-diameter ( $\varnothing 75 \text{ mm Z4-15}^\circ$ ), wide-tipped cutters operating at cutting speeds of 10.000 rpm. An excellent finish on PVC edge banding is guaranteed. The trimmers are powered by a high-power (0,37 kW), asynchronous, maintenance-free brushless motor. Furthermore, the unit has chromed plate copiers which are bearing mounted to ensure smooth feed. The pad/roller combination assures a great advantage: the panel feed is "softened" thanks to the wide radius of the pad and of the roller rotation, so as to avoid any scratch due to friction on the panels, particularly on upgraded panels.

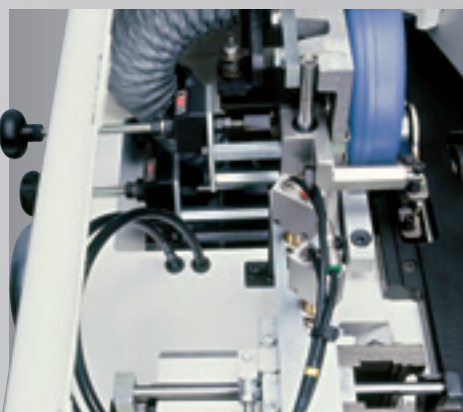

## Kit for rolled edges up to 2 mm thickness

**ME 15 - ME 20** | Kit for PVC, ABS edges (standard)

The kit allows the application of PVC and ABS edges with 2 mm maximum thickness.

It includes:



Adjustable infeed fence with numeric readout (mm/inches)

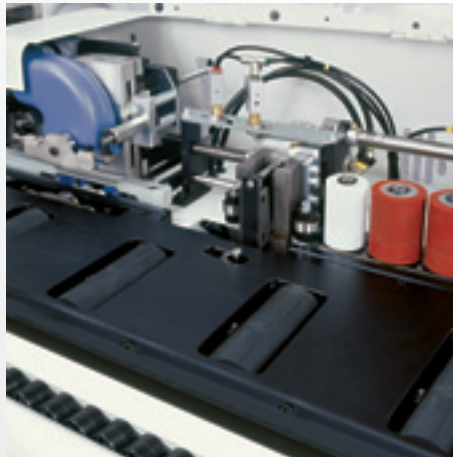

Rollers on the table for panel support and direction



75 mm cutters with shaped profile (2 mm radius)

**ME 20** | Kit for WOOD, PVC, ABS edges (optional)

This kit has been designed in order to avoid the wooden edge from breaking during the pressure and gluing phase.

In addition to the devices supplied in the Kit for PVC and ABS edges, i.e.:

> Adjustable infeed fence with numeric readout (mm/inches)

> Rollers on the table for panel support and direction

> 75 mm cutters with shaped profile (2 mm radius)

the kit also includes:



730 mm diameter coil holder plate with side limit rollers



First adjustable pressure roller

## ME 15 - ME 20

## Technical specifications

		ME 15	ME 20
Working table dimension	mm	1950 x 300	1950 x 300
Working table height	mm	904	904
Min./max. edge thickness	mm	0,4/2	0,4/2
Min./max. panel thickness	mm	12/45	12/45
Minimum panel length/width	mm	180/65	180/65
Power feeder speed	m/min	~ 5	~ 5
Trimmers speed	rpm	10'000	10'000
Standard carbide tip tools (trimmers)		Ø 75 mm Z4 -15°	Ø 75 mm Z4 -15°
Extractor hood outlet diameter	mm	120	120
Edge roll plate standard diameter	mm	730	730
Leister blower power	watt	3400	-
Operating temperature	°C	20 ÷ 450	~ 200
Glue tank motor power	kW	-	0,18
Feeder motor power	kW	0,18	0,18
Trimmers motor power	kW	0,37	0,37
Total weight	kg	250	270

## ME 15 - ME 20

## Overall dimensions

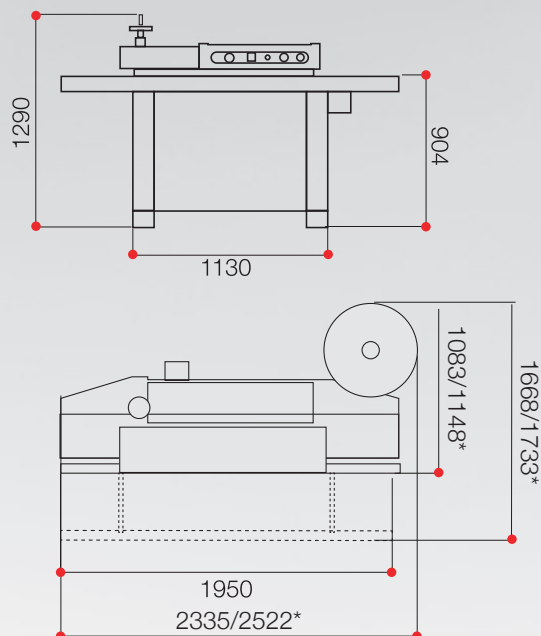

\*= with the optional kit for wood, PVC, ABS edges (ME 20)

*Praise from a Tecnomax customer: "ME 15 is the edge bander I was looking for. It takes up little space and means that I can obtain an excellent finish in a single pass. I don't have to use the old flat iron any more to keep my customers happy. At last, edge banding is within the reach of craft woodworkers like me!"*

*Edgardo Casali.*





| CU300 elite



| CU350 elite



| CU410 elite



| FS35 elite



| FS41 elite



| FS41 elite S



| SC4WS

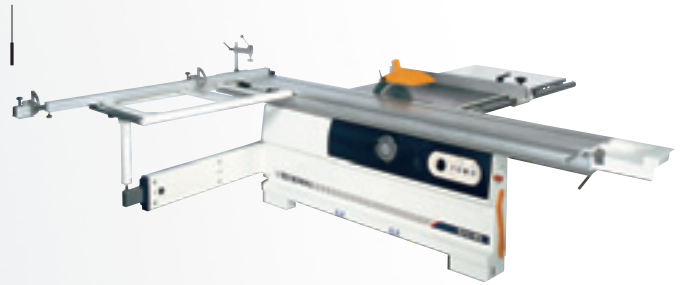

| S315WS



| S350WS



| ME 15



| ME 20



| MB 21

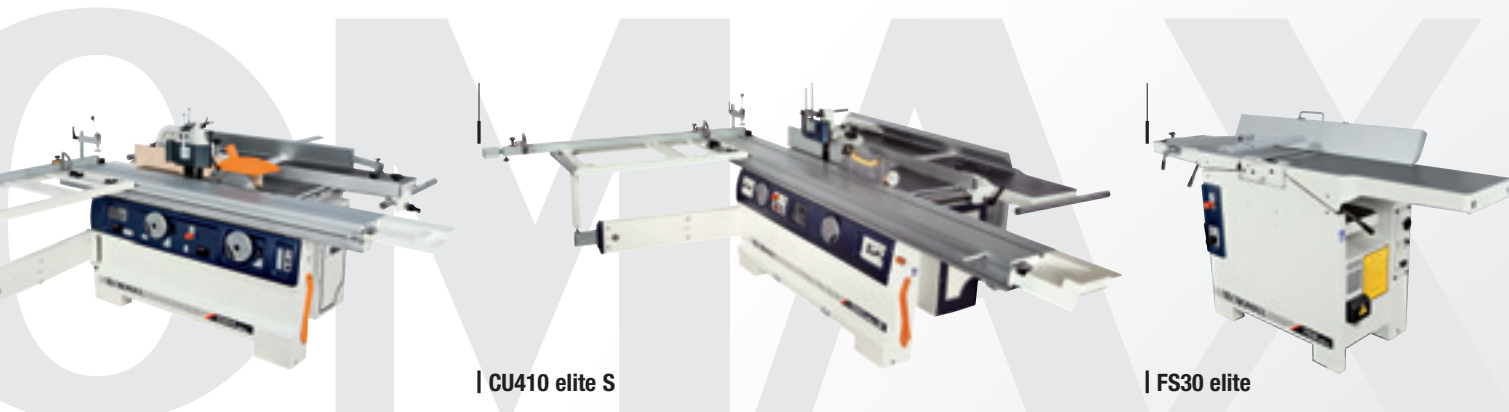

| CU410 elite S

| FS30 elite

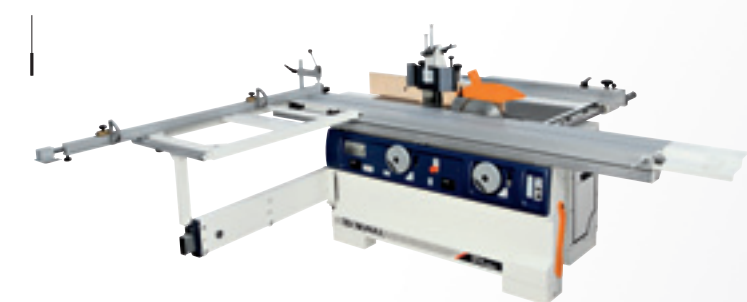

| ST4 elite



| ST5 elite S



| LS



| T55  
| T55W



| ROUTER



| UNILEV 150

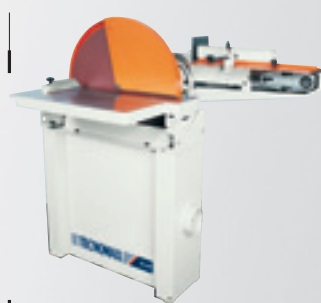

| DG 60



| S600P  
| S700P  
| S800P  
| S900P



**TECNOMAX**

**SCM GROUP spa**  
Via Casale, 450  
47826 Villa Verucchio RN Italy  
Tel. +39 0541 679580 - 679578  
Fax +39 0541 674273  
e.mail: [info@minimax.sm](mailto:info@minimax.sm)  
[www.minimax.sm](http://www.minimax.sm)